

GT3 PLUS

Endodontic Handpiece (GT)

USER MANUAL

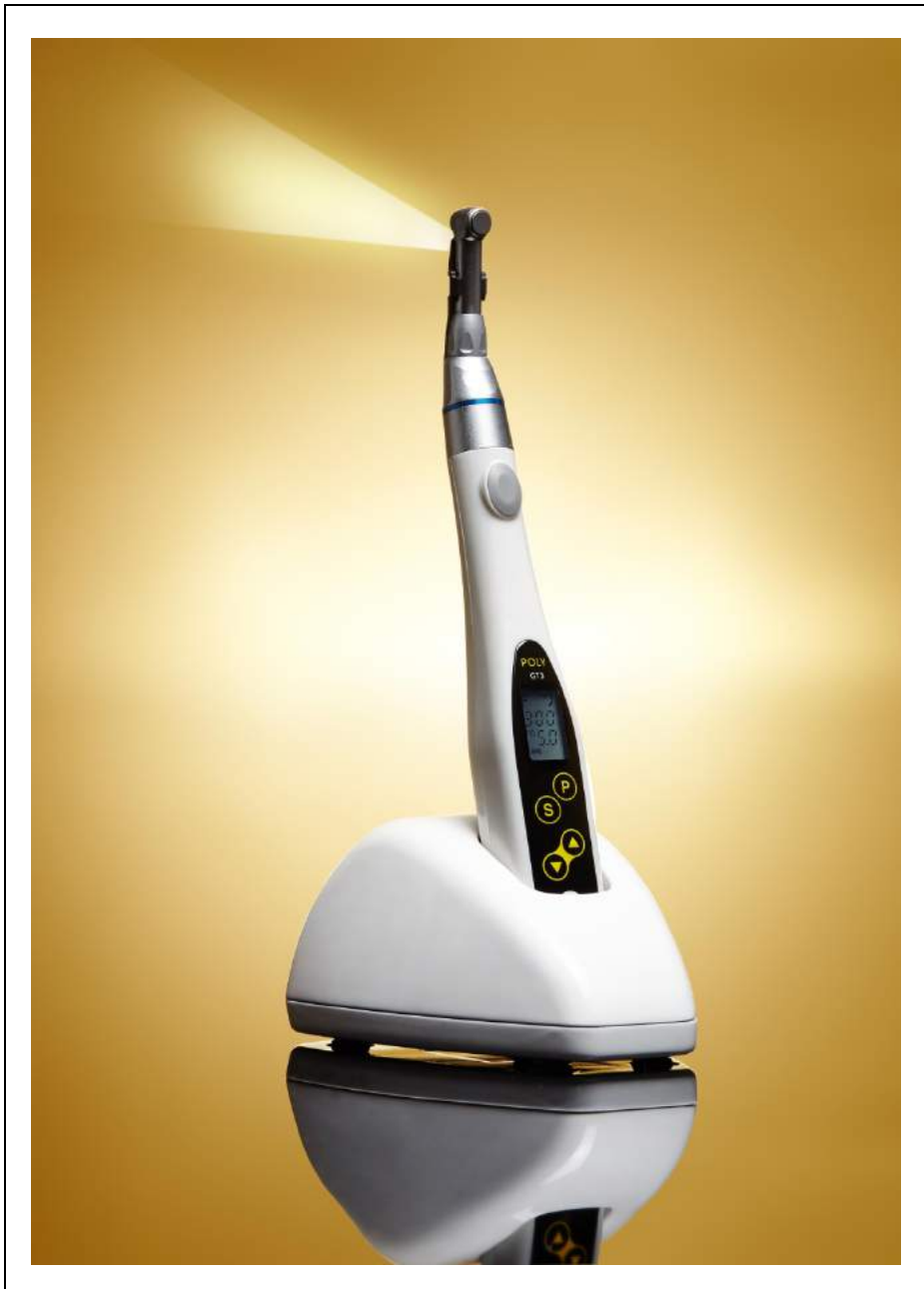

USER MANUAL

⚠ Read Instruction Before Use

SECTION 1: General Introduction

Cordless Endo Motor GT3 is a kind of endodontic micromotor to operate NI-Ti files, and it helps dentists to shape standard root canal following the treatment of root canal based on micro-electronic control technology. It will help the treatment of dentists.

Product application and intended use

Endo Motor GT3 is applied to endodontic treatment. It is used for treating the root canal pulp necrosis, chronic pulpitis, chronic apical periodontitis (including meat tooth apical swelling, periapical abscess, periapical cyst), periodontal pulp syndrome and systemic diseases should not be extract but urgent needed to be treat.



Unique advantages

Use Endo rotary file to enlarge the root canal , not only enlarges the root canal in straight situation, but also works for curved root canals.

1. It was designed based on ergonomic science. Also it was designed to reduce user's tiredness by placing the motor at the center of mass.
2. 4 different program which can be preset & memorized.
3. Auto-reverse and auto-stop function: When torque exceeds the limit, the file automatically reverse or stop.
4. Contra angle can be 135°C autoclaved.
5. Build-in rechargeable battery, greatly resolved the inconvenience of frequently replace the battery. In order to protect the life-span and working life of the battery, the machine will turn off automatically in 5 minutes without use.
6. If low battery, the machine will alarm to indicate operator.

SECTION 2: MAIN TECHNICAL INDEX

Model : GT3

- Type of protection against electric shock : Class II equipment: 
- Degree of protection against electric shock : Type B applied part: 
- Degree of protection against ingress of water: IPX0
- Operation mode : Continuous Operation

Product Specification

(1) Motor Handpiece

- Battery type : lithium-ion battery
- Input Voltage : 3.7V dc
- Rated Capacity : 700 mAH
- Size : 25 (width) X 27 (length) X 137mm (height)
- Net weight : 143g (head: 37g, main unit:104g, LED:2g)

(2) Charging base















- Size : 120 (width) X 80 (length) X 60 mm (height)
- Net weight : 73g

(3) Adaptor

- Rated input voltage : AC 100-240V 50HZ/60HZ
- Output voltage : DC 5V
- Output current : 1.2A

SECTION 3: Symbol

The following symbols may appear in this manual or on its accessories. Some of the symbols represent standards and compliances associated with endo motor and its use.

	Consult accompanying documents
	Cautions
	Authorized Representative in the European Community
	CE Mark: conforms to essential requirements of the Medical Device Directive 93/42/EEC.
	Date of manufacture.
	Manufacturer
SN	Specifies serial number
	Type B applied part
	Refer to instruction manual / booklet
	The device should not be used after the end of the shown or the day
	DISPOSAL: Do not dispose this product as unsorted municipal waste. Collection of such waste separately for special treatment is necessary.
	alert indicator displayed on the LCD screen
	Battery power sign displayed on the LCD screen
	AUTO REVERSE: If the load is removed after auto reverse rotation, it returns to the normal rotation again.
	AUTO STOP: If the load is removed after auto reverse rotations, it stops.
	AUTO REVERSE OFF: Auto reverse function is not activated.

SECTION 4: Product Structure

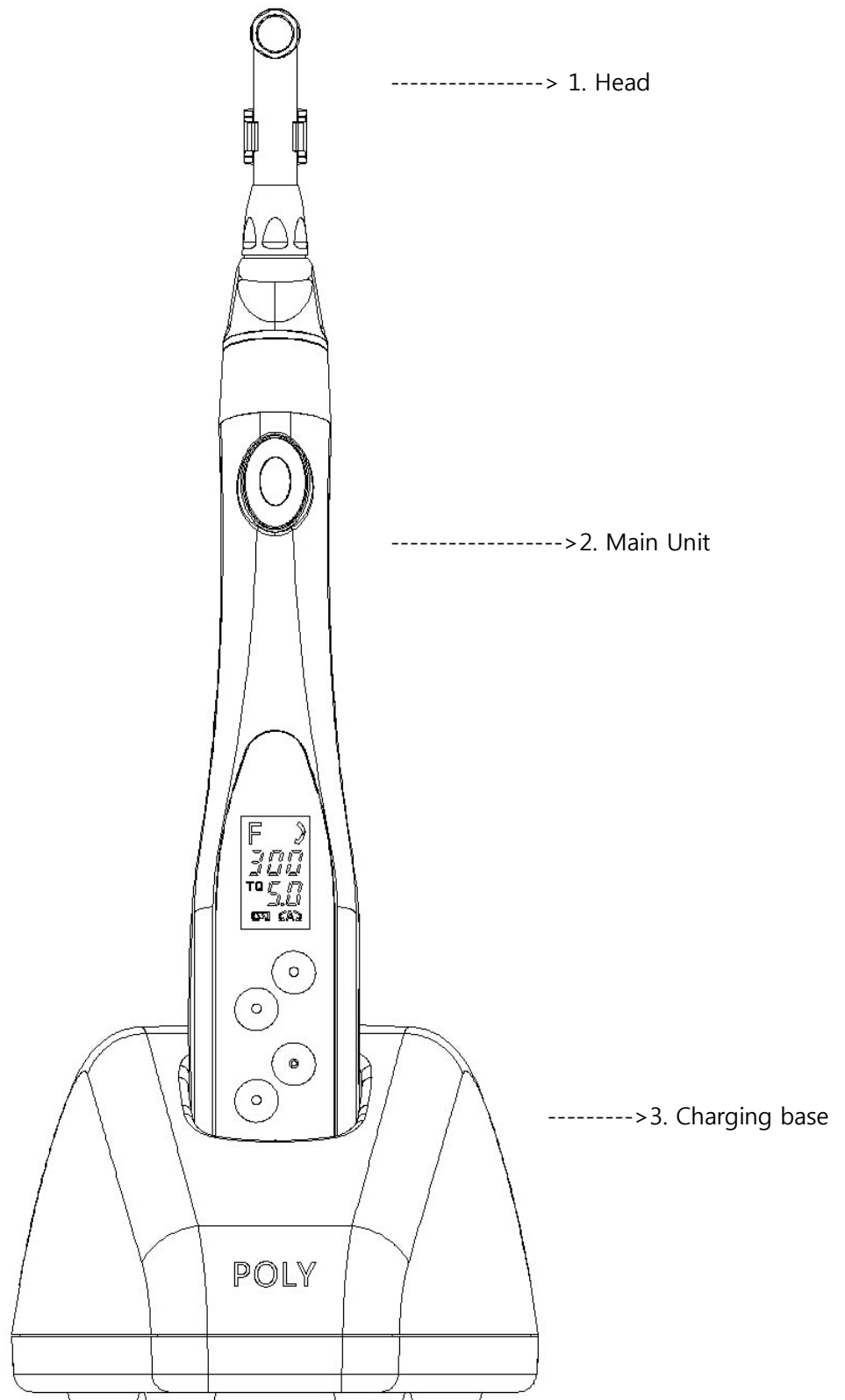

SECTION 5: Operation Panel and LCD Screen

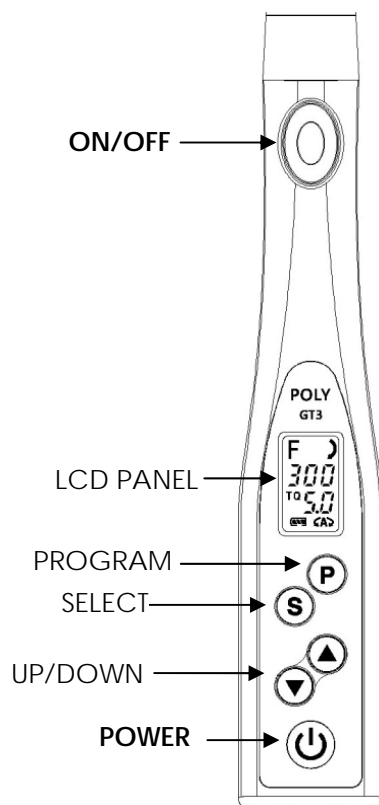

OPERATION PANEL

POWER

Holding down the POWER key for more than one second to turn on the power. Holding down the POWER key for more than one second while the power is on to turn off the power

ON/OFF

When the power is on, press ON/OFF key and the device start rotation, press this key again and the device stop rotation.

SELECT

To change Torque (TQ), Gear Ratio (GR), Speed (SP) and Auto reserve setting. The speed and torque can be changed while the file is in motion.

PROGRAM (memorize)

Holding down the PROGRAM key for more than one second choose program.

The following parameters can be set. (Torque, Gear Ratio, Speed and Auto reserve.)

UP/DOWN

To adjust the set value for each parameter

Speed: rpm, Torque: N.CM

Speed (rpm)	Gear ratio	Torque (N.CM)
100-450	20:1	0.3~5.0

LCD PANEL

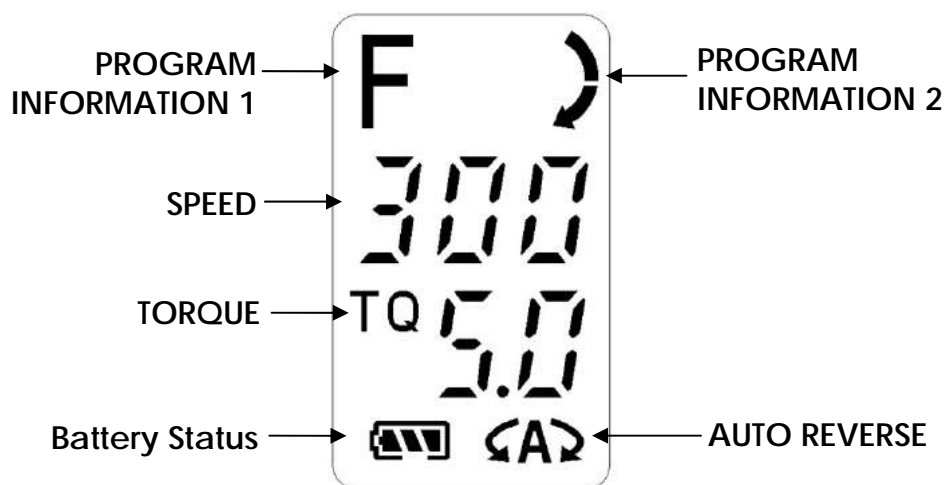

AUTO REVERSE

The present auto reverse mode mark is displayed.

 : AUTO REVERSING (If the load is removed after auto reverse rotation, it returns to the normal rotation again.)

 : AUTO STOP (If the load is removed after auto reverse rotations, it stops..)

 : AUTO REVERSE OFF: Auto reverse function is not activated.

BATTERY REMAINING

The mark of the present remaining amount of the batteries is displayed.

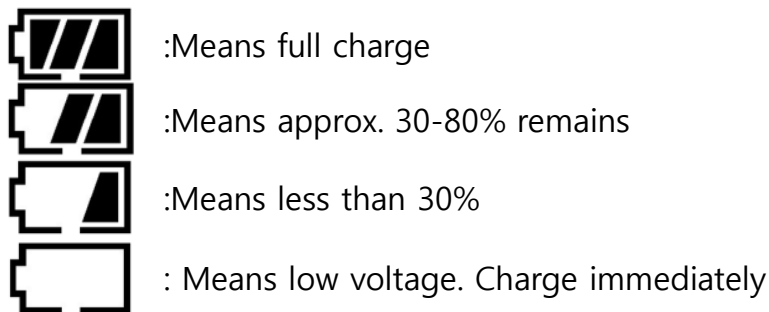

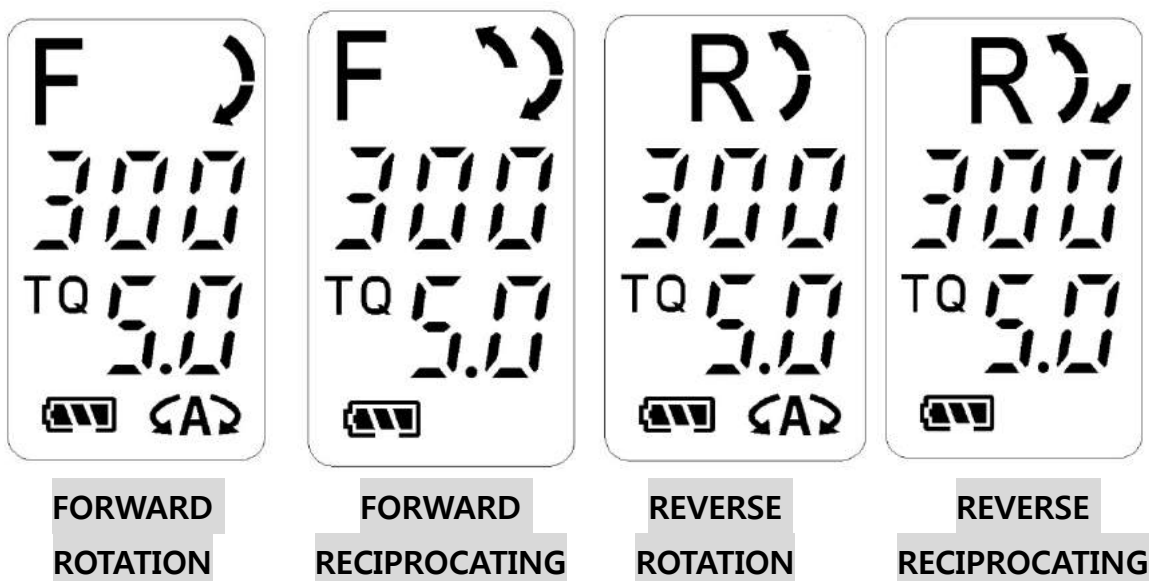

PROGRAM



Initialization of Program (Factory-set configuration)

The program can be reset to the original state Factory-set configuration

1	Turn on the power when the power is off.
2	Connect handpiece contra angle
3	Hold down the SELECT key  and Program key  more than five seconds.
4	The LCD panel indicates "CAL"
5	Press ON/OFF key 
6	Initialization is completed, when LCD panel display normally..

SECTION 6: OPERATION

1. Charge

- A. Connect the power adaptor to the charging base.
- B. Put the main unit on the charging base, during this period, please confirm if a beep is heard and the power display is flashing.
- C. If the beep has been heard, and the Power display shows "FUL", means the battery is full.
- D. During charging, the Power display shows "CHG".

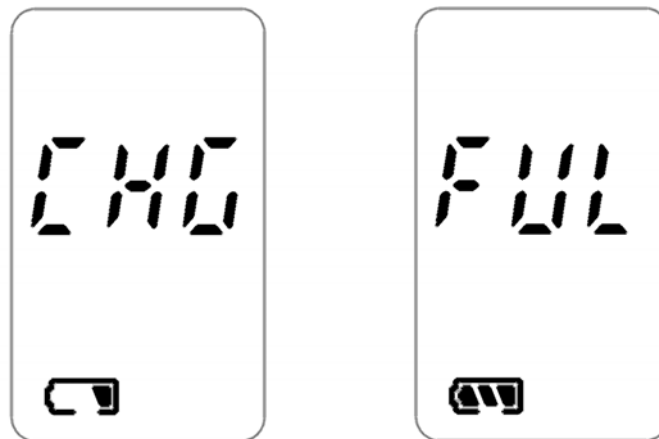

2. Contra angle install and uninstall

Connect the contra angle and main unit, please target the hole of main unit and contra angle until a sound can be heard. When uninstall the contra angle, please pull out in vertical direction.

3. The install and uninstall of bur

Insert the bur inside the contra angle and rotate lightly to find the right position, and then insert until a sound can be heard. When uninstall the bur, just press the push-button of contra angle to uninstall.

While uninstall the bur, please turn off the power.

While install the bur, please double confirm the bur has been successfully loaded.

Please keep the bur clean, dirty bur can cause a problem during operation.

4. Operation

Press the Power button to start the machine, press the engine on/off button to start the rotation, press again the engine on/off button to stop the rotation.

5. After the operation

Please press the power button to turn off the machine after the operation.

Auto turn off function

The machine will be automatically turned off after 5 minutes not using.

SECTION 7: NOTICE

Note: Please do not use improper bur because it will cause problems during operation.

Please use the right speed according to the bur manufacturer.

Please avoid putting the machine under high temperature such as sun light or fire.

While inserting the machine to the charging base, please make sure to put in the correct position in order to avoid break.

Please do not lubricate our Endo motor main unit & charging base.

Please do not autoclave our Endo motor main unit & charging base.

The endo motor is not water-proof, please keep it away from water or chemical liquid in order to avoid short-circuit.

Please do not fall down the main unit and charging base.

Please use our power adaptor to charge the machine.

Our Endo motor usually will not make electromagnetic interference to other equipment

Forbidden.

This product cannot be used to cardiac pacemaker patients.

Do not use with high-frequency surgical equipment and heart disease patients!

SECTION 8: troubleshooting guide

When trouble is found, check the following again before contacting your dealer.

Problems	Cause & Solution
The power is not turned on	The battery is empty. <ul style="list-style-type: none"> ● Charge the battery.
	The press time of the power button is short. <ul style="list-style-type: none"> ● Please press the power button long enough
	The POWER button is broken. <ul style="list-style-type: none"> ● Contact your dealer.
The battery can't be charged.	The adaptor didn't connect well. <ul style="list-style-type: none"> ● Please recheck the connection.
	The main unit is not put on the charger base correctly. <ul style="list-style-type: none"> ● Please place the main unit properly.
	The battery is out of order. <ul style="list-style-type: none"> ● Contact your dealer.
The LCD isn't turned on.	The battery is empty. <ul style="list-style-type: none"> ● Charge the battery
	The battery is not installed correctly. <ul style="list-style-type: none"> ● Contact your dealer.
There is heating on the connection part between hand piece and charging base.	The connection part between the hand piece and charging base is polluted. <ul style="list-style-type: none"> ● Clean the connection part. ● If it isn't solved, then contact your dealer.
The file equipped with the hand piece doesn't rotate or its power of rotation becomes weak.	The file isn't mounted to the handpiece correctly. <ul style="list-style-type: none"> ● Mount the file with the hand piece properly. Inner cartridge, middle gear and the central part of motor are broken <ul style="list-style-type: none"> ● Contact your dealer.
Auto-reverse function doesn't work.	The battery is very low. <ul style="list-style-type: none"> ● Charge the battery again.

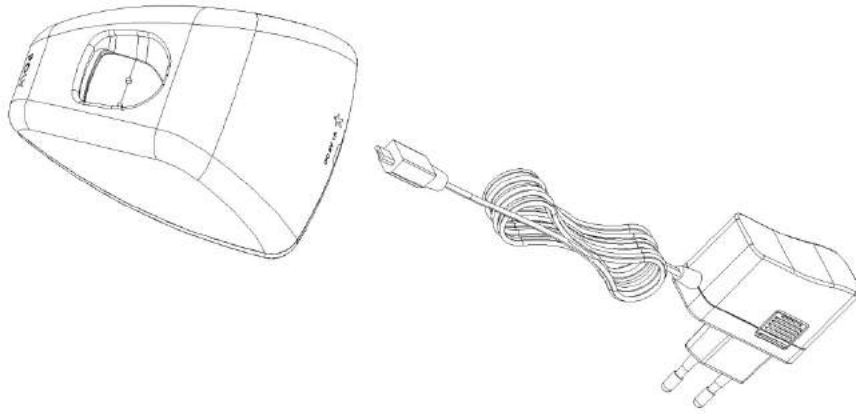

SECTION 9: MAINTENANCE

- 1) Please recharge the battery for 60 minutes each month and double-check every function whether it is OK.
- 2) When the surface of main body is polluted, please rub the surface with dry soft cloth ONLY by using neutral cleanser.

SECTION 10: Sterilization and lubrication

Please autoclave contra angle only.

Before autoclaving contra angle, please use spray to lubricate the contra angle..

We suggest use 135°C autoclave for 15 minutes. 121°C autoclave for 20 minutes.

The cleaned contra angle not in use, please seal in the sterilization bags and store it in a clean place

Remarks: The local temperature of bottom area is very high, so put the vessel in the middle or upper part of the disinfection cabinet

<IMPORTANT> - HOW TO LUBRICATE

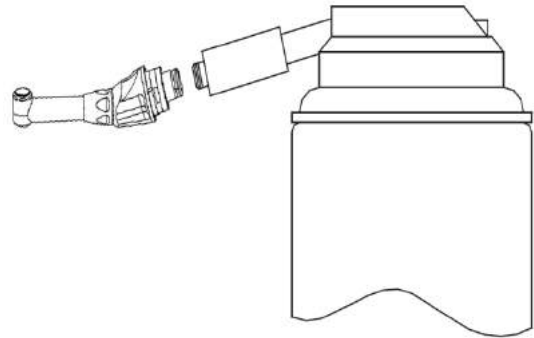

1) uninstall head and whole unit

2) Spray



3) uninstall head

4) Remove oil completely by using tissue or gauze and install them again

If you install them without removing oil completely, the motor would be broken caused by oil contamination to the motor.

SECTION 11: ENVIRONMENTAL REQUIREMENTS

OPERATING CONDITIONS

- Ambient temperature : +5°C ~ +40°C
- Relative humidity range : ≤80%
- Atmospheric pressure : 50kPa ~ 106kPa

STORAGE AND SHIPPING CONDITIONS

- Ambient temperature : -10°C ~ +50°C
- Relative humidity range : ≤80%
- Atmospheric pressure : 50kPa ~ 106kPa
-

Equipment is not suitable for storage in the presence of sunlight, rain, dust, and corrosive gasoline and volatile without poor ventilation.

SECTION 12: Packing List

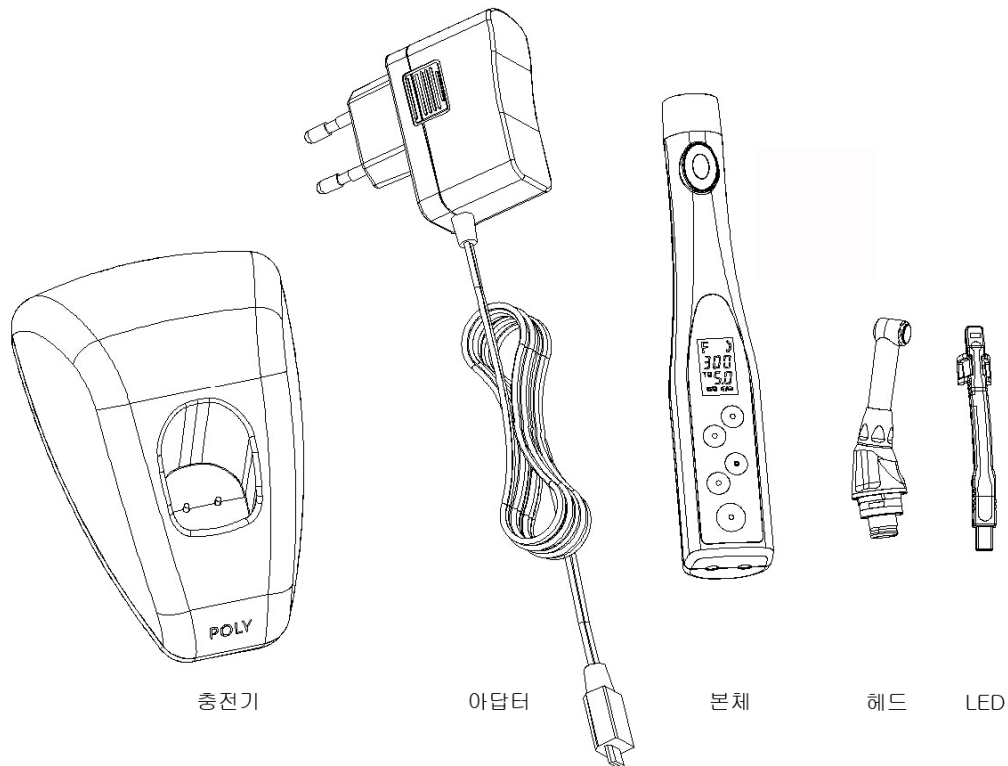

	product	quantity
1	Charging base	1pc
2	Adaptor	1pc
3	Main body	1pc
4	Contra angle	1pc
5	LED	1pc
6	User manual	1pc

SECTION 13: WARRANTY STATEMENT

This instrument described below has been fully inspected and confronts to the current products specification..

The device is maintained free of charge and doesn't require any routine maintenance within warranty period, a year.

Products warranty or service will not be extended

- (1) Product is repaired, modified, misused, disassembled, or using the parts are not provided by the manufacturer.
- (2) The serial number of the product is defaced or missing.
- (3) Damaged from incorrect use by user

If you need After Service, contact to dealer that you buy from.

Don't modify or uninstall the motor.

- This product should be repaired by the expert who is approved.
- This product should be used by a dentist.
- Electric supplying should be based on the standard of supplier or the requirements of the product.

SECTION 14: PRODUCT DISPOSAL

- Even though the used battery can be recycled, the environmentally correct method for disposing of the used battery may vary between countries. It is recommended, therefore, to return the used battery to your local dealer.